



RCF-230CAD

Room controller for fan-coil applications with two analogue 0...10 V DC outputs

RCF-230CAD is a room controller intended to control heating and/or cooling in 2- or 4-pipe installations. Setpoint and fan speed are set using the buttons on the front. RCF-230CAD offers communication via Modbus or EXOline.

- Supply voltage 230 V AC
- Two analogue 0...10 V DC outputs
- Built-in relays for a 3-speed fan, 230 V AC
- Backlit display

RCF-230CAD is a controller for controlling heating and/or cooling in a room. It is intended for control of actuators with 0...10 V DC analogue control signal, and also has a function for three-speed fan control (for fan-coil).

The controller has supply voltage 230 V AC. It has built-in 230 V AC fan relays, which means that a separate relay module is not required for the fan and actuators.

For integration into a system, RCF-230CAD has communication via RS485 (Modbus or EXOline). The device can be configured using the application Regio tool, which can be downloaded from the Regin web site (www.regin.se).

Applications

The controller is suitable in buildings where you want optimal comfort and reduced energy consumption, for example offices, schools, shopping centres, airports, hotels and hospitals etc.

Design

The controller has a modern design, inspired by the award-winning design of Regin's Regio controllers.

Simple installation

The modular design with a separate bottom plate for wiring makes the controller easy to install and commission. The bottom plate can be put into place before the electronics are installed. Mounting is directly on the wall or on a wall socket.

- Input for occupancy detector or window contact
- Input for automatic change-over cooling/heating
- Communication

Control function

The controller controls heating and/or cooling in a room. Control parameters like P-band and I-time can be set via the display, or alternatively via Regio tool. The setpoint can be changed using the INCREASE (▲) and DECREASE (▼) buttons on the front.

See also the section "Display information and handling" on page 2.

Built-in or external sensor

The controller has a built-in sensor. Alternatively, the input for an external PT1000-sensor can be used.

Output function for actuators with 0...10 V control

The controller has 0...10 V DC outputs. Since it is powered by 230 V AC, the analogue signal neutral on the controller must, in addition to the control signal's plus signal, be connected to the actuator in order for the control signal voltage to be transferred.

The output signal for the two outputs can be set individually to 0...10 V, 2...10 V, 10...0 V and 10...2 V. The factory setting is 0...10 V for both outputs.

2- and 4-pipe installations

In 2-pipe installations, the same pipe system is used for heating and cooling. Chilled water is distributed in the system during summer and heated water during winter. When RCF-230CAD is configured for a 2-pipe system, output AO1 is used for controlling heating or cooling (depending on the season (fluid temperature)) via an actuator, a valve or similar (change-over function).

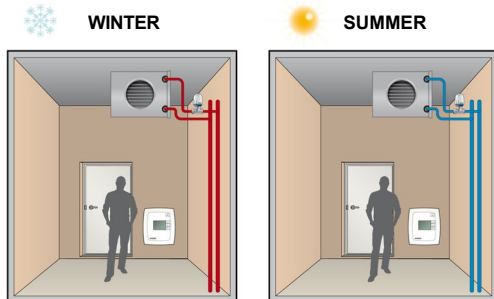

In 4-pipe installations, there are two separate pipe systems for heating and cooling with separate valves. The controller uses two outputs for control of heating and cooling in sequence.

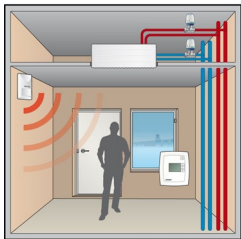

Automatic change-over cooling/heating (so-called change-over function)

RCF-230CAD has an input for change-over which is used when the controller is configured for 2-pipe installations. It sets output AO1 to operate with heating or cooling function depending on the fluid temperature (season).

The change-over input can be connected to a potential-free relay contact or a PT1000-sensor.

The input function for the relay contact can be set to normally open (NO) or normally closed (NC). If the change-over input is not used, we recommend that it is left disconnected and set to NO (factory setting).

When using a sensor, it must be mounted so that it can measure the temperature on the supply pipe to the coil. To ensure satisfactory function, the system must also have continuous primary circuit circulation. Using a sensor, the output function is set to heating when the fluid temperature exceeds 28°C and to cooling when the temperature falls below 16°C.

At heating function "HEAT" is shown in the display and at cooling function "COOL" is shown.

Occupancy detection for saving energy

By connecting an occupancy detector or a keycard switch (in hotels) to a digital input, it is possible to change between Comfort and Economy mode. This way you can control the temperature according to requirement, which saves energy and keeps the temperature at a comfortable level.

Using occupancy detection, it is possible to delay activation and/or inactivation of Comfort mode, to avoid switching mode if a person temporarily enters or leaves the room.

Alternatively, a window contact can be connected to the input. This sets the thermostat to Off if a window is open with the purpose of minimising energy consumption.

Operating mode

There are four different operating modes, Comfort, Economy (Standby), Off and Window. Switch-over between these modes is performed locally or through the master system.

Comfort: is shown in the display and the room is in use. The temperature is held at the comfort level with a neutral zone (NZC) between activation of heating and cooling (factory setting for NZC = 2 K (°C)).

Economy (Standby): "Standby" is shown in display. The room is in energy save mode and is not used at the moment. This can for example be during nights, weekends, evenings etc. or during daytime when there is no one in the room. The controller is prepared to change operating mode to Comfort if someone enters the room. The heating and cooling setpoints are freely adjustable. Factory settings: heating=15°C, cooling=30°C.

Off: "Off" is shown in the display and the backlight is switched off. The controller does not heat or cool and the fan is inactive, unless mould protection function has been configured, in which case the fan will continue to run. Off mode is selected by pressing the On/Off button.

Window: is shown in the display. The controller is in Off mode but the display is lit. Mould protection is active if it has been configured.

Automatic fan speed control

The current fan speed is shown in the display and can be set manually to Low, Medium or High speed. It can also be set to Auto, which means that the fan speed is controlled by the heating and/or cooling demand, depending on the configuration.

The fan speed is set to Low→Medium→High→Auto by pressing the fan button.

The factory setting in the Auto position is that the fan speed is controlled at both heating and cooling demand. The first step starts when the output signal from the controller internally exceeds

20 %. The second step starts at 60 % and the third at 100 %. When the fan speed decreases, each fan step has a hysteresis of 5 % for changing over to the next step. For example, the fan will change from the third to the second step when the output signal falls below 95 %.

The values of the fan start points, the hysteresis and the choice of control based on the heating and/or cooling demand can be changed via the display or through Regio tool. The number of fan steps can also be changed if the fan has less than three steps.

When there is no heating or cooling demand in the Auto position, the fan will run at the lowest speed. This can be changed in parameter 31 so that the fan stops when there is no heating or cooling demand. The fan is inactive in the Off and Window modes. However, it will continue to run if mould protection has been configured.

Mould protection

When this function has been configured, the fan will continually run (at its lowest speed, if not set otherwise) and circulate air in the room so as to minimise the risk of mould growth in the fan-coil unit. The function is deactivated on delivery.

Automatic exercise of valves

The controller has a function for exercising the valves, even during periods when they are not being used, to ensure proper function. Every 23 hours (factory setting), the output is overridden to close for a moment in order to open and close the valves. The exercise interval can be set individually for heating and cooling. The exercise function can also be inactivated if desired.

Display information and handling

The display has the following indications:

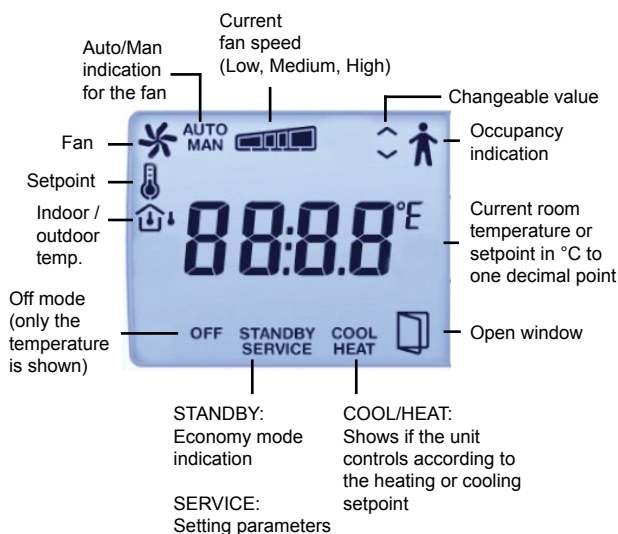

The display is handled using the buttons on the controller:

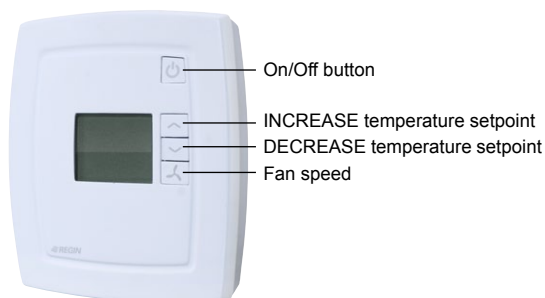

On/Off button

By pressing the On/Off button, RCF-230CAD will switch between Off mode and Comfort/Economy mode.

Setpoint buttons

The INCREASE and DECREASE buttons are used for changing the setpoint value. What is shown in the display can be configured via the parameter list. There are four alternatives:

1. The actual value is shown, or, when the setpoint has been changed via the INCREASE and DECREASE buttons, the setpoint value is shown in the display (together with the setpoint (thermometer) symbol).
2. The actual value is shown, or, when the setpoint has been changed via the INCREASE and DECREASE buttons, the setpoint adjustment value is shown in the display (together with the setpoint (thermometer) symbol).
3. The setpoint value is shown (factory setting).
4. The setpoint adjustment is shown.

When the setpoint adjustment is displayed (alternatives 2 and 4), the basic setpoint is 22°C.

The minimum limitation of the setpoint value is settable 5...22°C and the maximum limitation is settable 22...35°C.

Fan button

By pressing the fan button, you set the fan speed to Low, Medium, High and Auto.

Configuration

The factory settings can be changed in the display using the buttons on the controller, or alternatively via Regio tool.

The parameter values are changed with the INCREASE and DECREASE buttons and changes are confirmed with the On/Off button.

The parameter list can be found in the instruction for RCF-230CAD.

Control principles

Control principle at cooling function, 2-pipe installations

When the controller is set to cooling, the output starts to increase when the temperature rises above the setpoint value.

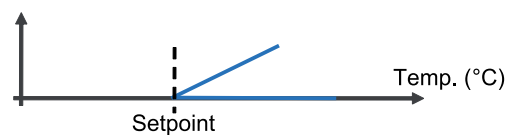

Control principle at heating function, 2-pipe installations

When the controller is set to heating, the output starts to increase when the temperature falls below the setpoint value.

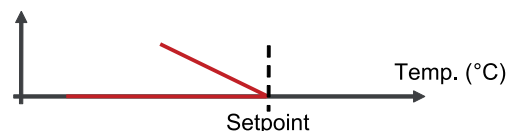

Control principle at 4-pipe installations

At Comfort mode, neither heating nor cooling is used when the temperature is in the neutral zone, in order to minimise the energy consumption. The heating output is activated when the temperature falls below the set value for the neutral zone. The cooling output is activated when the temperature exceeds the set value for the neutral zone. The neutral zone is divided into two equal parts with one part below and one part above the setpoint. See the figure below. The factory setting for NZC is 2 K.

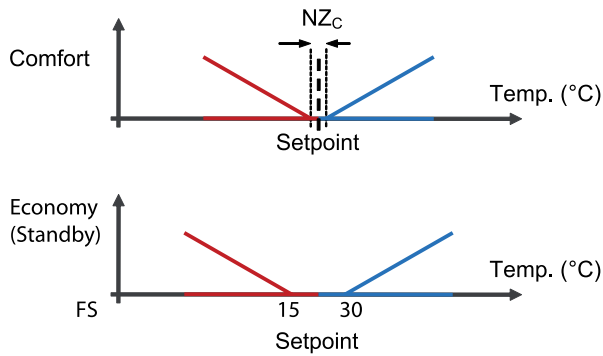

The above schematic drawings of the control principle show the corresponding requirement of the controller function. This requirement is recalculated by the controller to a value for the actuator output, depending on the selected output function.

Technical data

Supply voltage	230 V AC \pm 10 %, 50/60 Hz
Power consumption	3 W, class II construction
Ambient temperature	0...50°C
Storage temperature	-20...+70°C
Ambient humidity	Max. 90 % RH
Protection class	IP20
Pollution degree	2
Overvoltage category	3
Display	LCD with backlight
Built-in temperature sensor	NTC type, measuring range 0...50°C
Terminal blocks	Lift type for maximum cable area 2.1 mm ²
Material, casing	Polycarbonate, PC
Colour	
Cover	Polar white RAL9010
Bottom plate	Light gray
Mounting	Indoor, wall mounting, fits on a standard wall socket
Dimensions (HxWxD)	120 x 102 x 29 mm
Weight	0,18 kg



This product conforms to the EMC and LVD requirements in the European harmonised standards EN 60730-1:2000 and EN 60730-2-9:2002 and carries the CE mark.

Inputs

External sensor, AI1	PT1000-sensor. Suitable sensors are TG-R5/PT1000, TG-UH/PT1000 and TG-A1/PT1000 from Regin. The setpoint range is 5...35°C.
Change-over, UI1	Potential-free contact or PT1000-sensor. A suitable sensor is TG-A1/PT1000 from Regin.
Occupancy/window contact, DI1	Potential-free contact. A suitable occupancy detector is IR24-P from Regin.

Outputs

Fan control, DO1, 2, 3	3 outputs for speed I, II and III, 230 V AC, max. 3 A fan-coil
Valve, DO4, DO5	2 outputs, 230 V AC, 300 mA max. (20 A max. 20 ms)
Output AO1, AO2	0...10 V DC, max. 1 mA, short-circuit proof, reversable to 2...10 V, 10...0 V, 10...2 V
Communication	RS485 (Modbus or EXOline) using automatic detection/switching
Modbus	8 bits, 1 or 2 stop bits. Odd, even (FI) or no parity
Communication speed	9600 bps (not changeable); communication variables are in the RCF manual, available via the Regin web site.

Settings

		Factory setting (FS)
Setpoint	5...35°C	22°C
Setpoint, min. limit	5...22°C	-
Setpoint, max. limit	22...35°C	-
Internal sensor calibration	-10 K...10 K	0 K
External sensor calibration	-10 K...10 K	0 K
Hysteresis	0.5..0.50 K	1 K
P-band	1...300°C	10°C
I-time	0...1000 s	300 s
NZC, neutral zone at Comfort	0.1...10 K	2 K
Installation type	2- or 4-pipe	2-pipe
Input DI1	Normally open (NO) or normally closed (NC)	NO
Input UI1	NO or NC, when used as a relay contact input	NO
Valve exercise	Individually settable for heating and cooling outputs	23 hours interval

Wiring

10	L	230 V AC Line	Supply voltage
11	NC	Not connected	
12	N	230 V AC Neutral	Power supply (internally connected to terminal 13)
13	N	Fan-coil common / 230 V AC Neutral	Common fan-coil connector (internally connected to terminal 12)
20	DO1	Fan-coil output 1 for fan control	Relay, 230 V AC*, 3 A
21	DO2	Fan-coil output 2 for fan control	Relay, 230 V AC*, 3 A
22	DO3	Fan-coil output 3 for fan control	Relay, 230 V AC*, 3 A
30-33	NC	Not connected	
40	DI	Digital input	Floating (potential-free) window contact or occupancy contact. Configurable for NO/NC.
41	0 V	Analogue ground	
42	AI	Analogue input	External PT1000 instead of the internal NTC
43	UI	Universal input	Change-over input. Potential-free switch (configurable for NO/NC) or PT1000.
44	0 V	Analogue ground	
50	0 V	Analogue ground	
51	AO1	Analogue output 1	
52	AO2	Analogue output 2	
53	A	RS485 communication A	
54	B	RS485 communication B	

*The sum of the current through DO1-DO3 is protected by a fuse

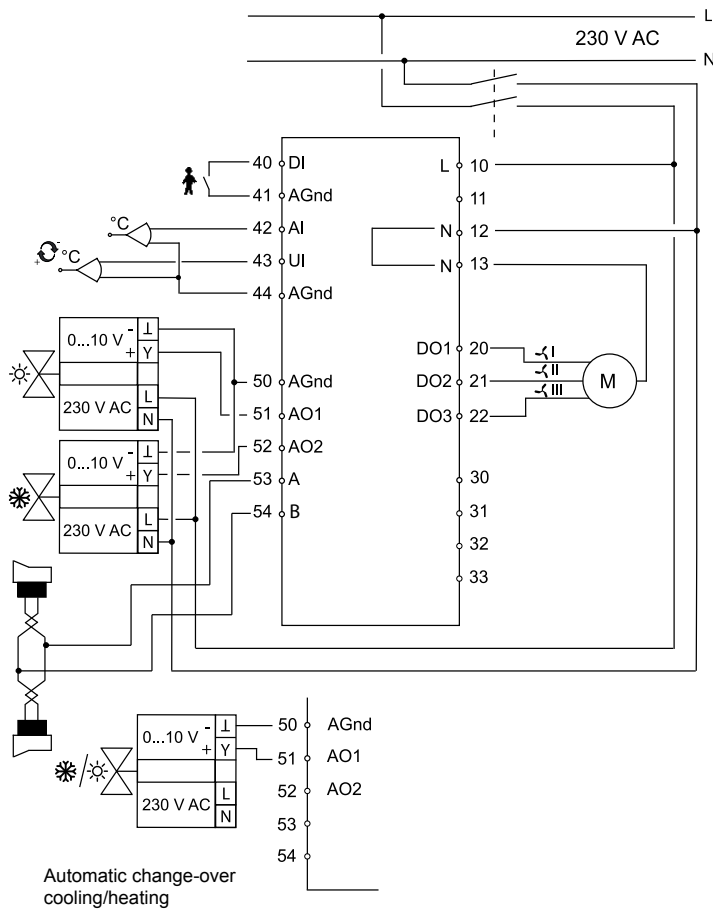

Dimensions

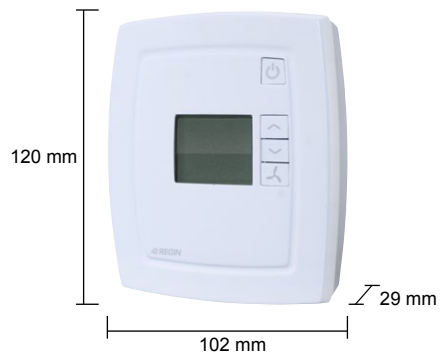

Product documentation

Document	Type
Instruction RCF-230CAD	Instruction for RCF-230CAD